

VOLTEX® INSTALLATION GUIDE

LED Panel Light Suspension Cable Set LPL-CABLE

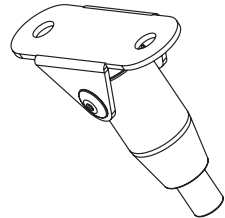
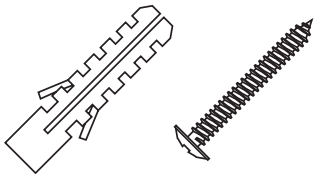
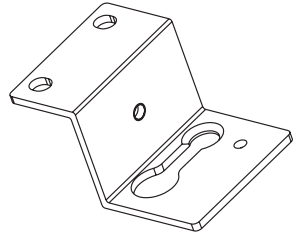
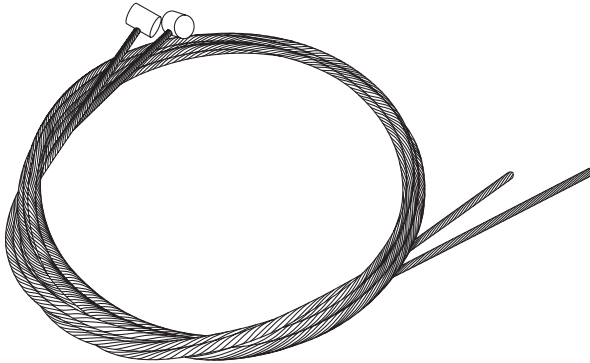

VOLTEX®

© Voltex Electrical 2020. All Rights Reserved.

AU P: 1300 722 275
E: sales@voltexelectrical.com.au
www.voltexelectrical.com.au

NZ P: 0800 55 66 33
E: sales@voltexelectrical.co.nz
www.voltexelectrical.co.nz

INSTALLATION INSTRUCTION

MAXIMUM LOAD RATING: **15KG**

- 1** Fix the anchors into the ceiling.

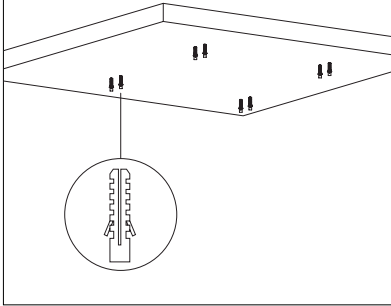

- 2** Fasten the ceiling mount bracket onto the ceiling, and thread cable through the hole.

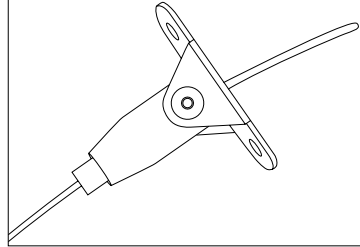

- 3** Attach the brackets to the panel light using existing screws, and hang the panel to the ceiling using the cable.

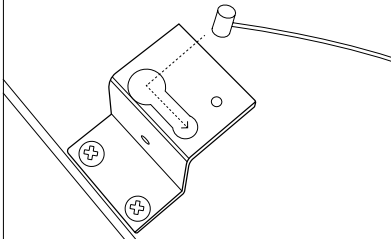

- 4** Adjust the length of the cable accordingly.

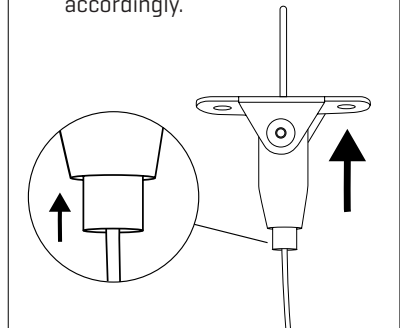

- 5** When complete, connect the power supply.

