









SWITCHED SOCKETS

Specifications

Cover Material	Polycarbonate Blend
Protection Type	Without protection [No RCD]
IP Rating	IP66
Optimum Operating temperature	-25 to +50C
UV Resistant	Yes
Chemical Resistance	Suitable for environments with milder chemicals/oils
Cable entry in enclosure	25mm x 2 and 32mmx1
Max Terminal size for cable	25mm ²
Appropriate entry reducers included	

Reference	Volts	Amp	Pin No	Socket Conf.	M Rating	AC Rating
C66C332RW	250	32	3		100	AC22A
C66C420RW	500	20	4		100	AC22A
C66C510RW	500	10	5		100	AC22A
C66C520RW	500	20	5		100	AC22A
C66C532RW	500	32	5		100	AC22A
C66C540RW	500	40	5		200	AC22A
C66C550RW	500	50	5		200	AC22A

Dimensions

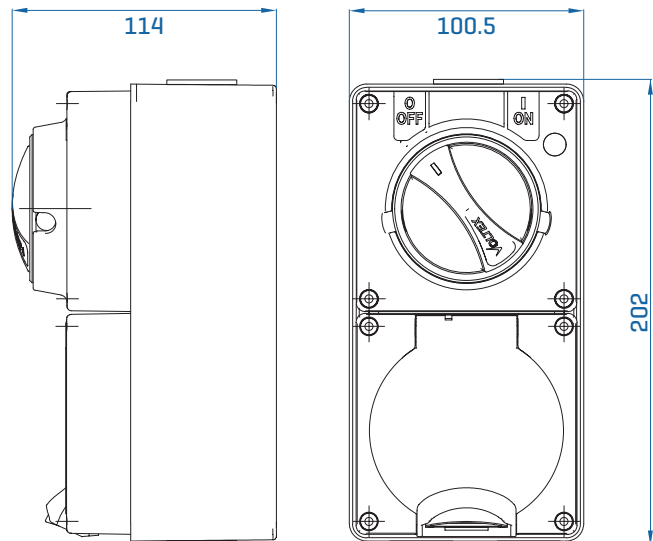

Compliance

AS 60529:2004/NZS IEC 60947.1:2015 Annex C
AS/NZS 3121:2002
AS/NZS 3100:2009+A1-A4

