

VOLTEX® INSTALLATION GUIDE

SUNSET SWITCH
WPSS-16

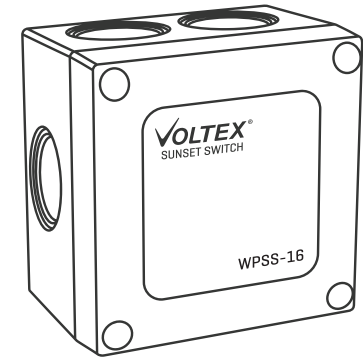

INTRODUCTION

The Voltex Sunset Switch is a photo-electric sensor that automatically turns a load ON at dusk and OFF at dawn, or at a pre-determined time.

OPERATING MODES

The four operating modes are easily set via switches on the product

Mode	Description
1 Dusk-Dawn Mode (DEFAULT Mode)	Turns the load ON at dusk and OFF at dawn. The product is supplied set to this mode
2 Delay Timer mode	Turns the load ON at dusk and runs for a pre-set length of time every night. The ON time can be set in 30 minutes increments, from 30 minutes to 15.5 hours
3 Real Time Mode	Turns the load ON at dusk and OFF at the same set time of night, every night
4 ECO mode	Turns the load ON at dusk, OFF during the middle of the night, and back ON again until dawn

VOLTEX®

Australia

www.voltxelectrical.com.au

P: 1300 722 275 E: sales@voltxelectrical.com.au

New Zealand

www.voltxelectrical.co.nz

P: 0800 55 66 33 E: sales@voltxelectrical.co.nz

© Voltex Electrical 2020. All Rights Reserved.

SPECIFICATIONS



The product includes a turn ON delay and a turn OFF delay of 1 minute to prevent false switching

Operating Voltage	220 – 240Vac 50Hz
Operating Temperature	0 to +50°C
Certified Standard	CISPR15, AS/NZS 61347.2.11
Ingress Protection	IP66
Maximum switching capacity	16A
Maximum Load	5A LED 16A incandescent and halogen 16A fluorescent
Minimum Load	0W
Switching levels	ON – 25 Lux, OFF – 50 Lux
Turn ON/OFF delay	1 minute
Timer Range	30 minutes to 15.5 hours
Timer Steps	30 minutes

INSTALLATION



This product should only be installed by a licenced electrician in accordance with all the requirements of AS/NZS 3000 (current edition) and other relevant Standards and Regulations

IP RATINGS

To maintain IP66 rating, all used cable entries must be sealed with a silicone sealant and front cover screws must be fully tightened, with all screw blanking plugs used cable entries.

PLACEMENT

The Sunset Switch should be placed where it receives sufficient indirect sunlight, preferably facing south.

The unit should not be installed where,

1. the translucent front cover receives direct sun light, or,
2. where the Sunset Switch receives light directly from the lights it is switching, otherwise the load may switch ON and OFF at 1-minute intervals.

WIRING

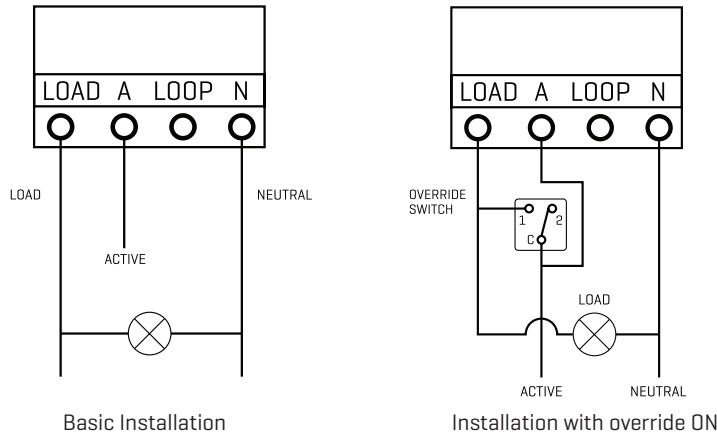

When power is first applied, the unit will switch ON for a one-minute test period and will then resume normal operation.

TESTING

To test the Sunset Switch during daylight hours, after the initial one-minute test period, fully cover the unit with the product box (with black insert) and wait for at least one minute until the load turns ON.

MODES OF OPERATION



Electrical safety warning
Isolate the device from the mains power supply before setting the required mode of operation

MODE1 - DUSK-DAWN MODE (DEFAULT) [ALL SWITCHES OFF]

ON at dusk, OFF at Dawn

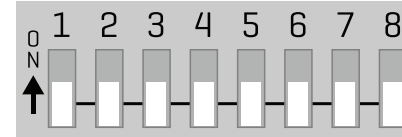

MODE2 - DELAY TIMER MODE [SWITCHES 6,7 & 8 OFF]

Fixed-ON time after dusk

A fixed delay time of 30 minutes up to 15 hours and 30 minutes can be set.

Switches 6-8 are in the OFF position. Switches 1-5 as set to provide the required delay OFF time.

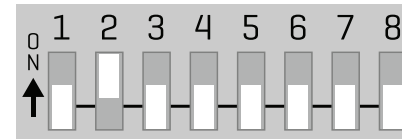

Switches 6,7,8
always OFF in Delay
Timer Mode

30m 1h 2h 4h 8h

Switches 1-5 used to set ON
time after dusk

Delay OFF timer Examples

ON time after dusk	Switch positions
1 hours after dusk	
2 hours after dusk	
3 hours after dusk	
4 hours after dusk	

ON time after dusk	Switch positions
5 hours after dusk	
6 hours after dusk	
7 hours after dusk	

MODE3 - REAL TIME MODE [SWITCH 7 ON, SWITCH 8 OFF]

Allows the selection of a fixed turn OFF time every night.

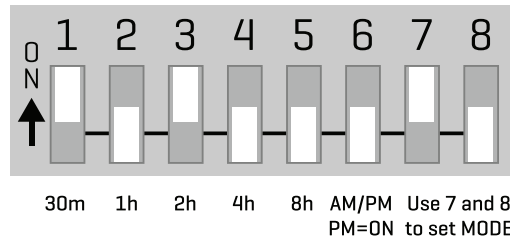
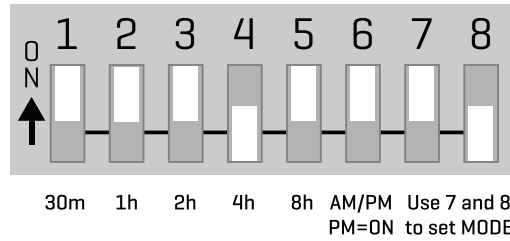

In real time mode the load will turn ON at dusk and OFF at the same desired time each night.

Turning switch 7 ON [up] and Switch 8 OFF [down] will set the unit to run in Real Time Mode, with switches 1-6 used to set the required turn OFF time.

! In Real Time mode, when power is first applied, the load will run in dusk-dawn mode on the first night and then will turn OFF at the desired time from the second night onwards.

! If the chosen OFF time occurs after sunrise [or before sunset] the unit will turn on at dusk and turn off at dawn

! Daylight savings will shift the desired turn off time by one hour, earlier or later depending on the time of year when power is applied to the unit

! Incorrect settings such as 00:00AM, 00:00PM, 13:00AM, 13:00PM, will result in the unit running in dusk-dawn mode

MODE4 - ECO MODE [SWITCH 8 ON]

In ECO mode, the unit will switch the load ON at dusk for approximately 50% of the night, then OFF in the middle of the night, and then ON again until dawn.

The ON and OFF times will automatically adapt to the changing seasons.

Switch 8 is ON to set ECO Mode. Switch 7 is used to set the length of the OFF period during the middle of the night

7 set to OFF	The unit will switch ON at dusk for approximately 50% of the night, then switch OFF for approximately 35% of the night, then ON again until dawn
7 set to ON	the unit will switch ON at dusk for approximately 50% of the night, then switch OFF for approximately 25% of the night, then ON again until dawn

Examples

With switch 7 set to OFF, if dusk is at 8:30PM and dawn is at 6:30AM, then in ECO Mode the unit will turn the light ON at dusk for approximately the first half of the night until 1:30AM, when it will turn the light OFF for approximately the next 35% of the night until 5:00AM, when it will turn the light ON again for the part of the night until dawn.

Summer

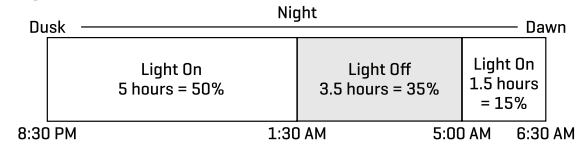

Winter

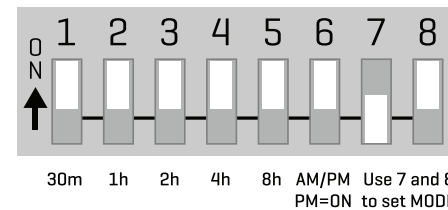
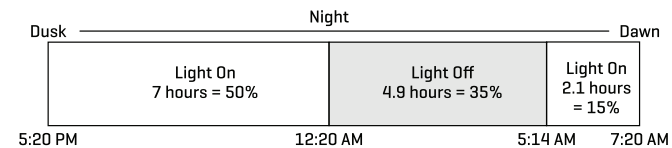

! When power is first applied, it will take between 24 to 48 hours for the unit to determine the appropriate switching times. During the first night it will run in dusk-dawn mode. If power is lost to the unit at any time, the unit will again require 24 to 48 hours to recalculate the switching times